

Zephyr®

RUBBER HOSES

HOSE REELS

WASH-STATIONS

ACCESSORIES



2023 Edition



THE ONLY
**END TO END
MANUFACTURER**
OF BOTH
HOSES & HOSE REELS
IN THE WORLD

What that means for you:

- Quality Control
- One-stop Variety
- Ecosystem Compatibility
- Unbeatable Lead-times
- Economies of integration & scale
- In-stock spare part programme

MADE IN INDIA

GLOBAL PRESENCE

- Australia
- Austria
- Belgium
- Canada
- Denmark
- Finland
- Germany
- India
- Ireland
- Netherlands
- Norway
- Poland
- Scotland
- South Africa
- Spain
- Sweden
- Switzerland
- United Kingdom
- United States of America

COMPANY



YouTube



Zephyr Videos



RMX Back Story



About RMX

RMX Industries (formerly R.M. Exports) – the largest exporter of Rubber Air & Water hoses from India. Manufacturing since almost 30 years back, RMX Industries sells in over **20 countries**, most of it across North America & Europe. The inventors of revolutionary **BluBird** range – the lightest, strongest, most flexible rubber hoses on the market today. It is fast becoming the favourite hose for professionals and DIYers alike in the Construction, Automotive, Agriculture & Industrial Markets.

RMX bought rubber hoses back in game. Innovating constantly but not for the sake of it but for truly helping the end-users by listening to them, RMX has become a formidable name in the hose market distributors across USA, Canada, UK, Ireland, Scotland, Sweden, Denmark, Finland, Germany, Switzerland, Austria, Netherlands, Belgium, Spain, Norway & Poland.

RMX manufacturing facilities are ISO 9001:2015 certified and in also compliant with many health/safety regulations as well as CTPAT.

And RMX Rubber is the India specific arm of RMX Industries. And brings the BluBird range of hoses, reels and accessories to India under the brand name **Zephyr**. Already a major hit and the go-to brand for garden consumers in India only a couple of years after launch, Zephyr is now ready for its forte – the professional and industrial market. Those who'd not compromise on quality of both product and service. This time, made in India, made for India.

NEW LAUNCHES

WIRE BRAIDED OIL HOSE REELS

XL Size, Single and Dual Arm



SUPER HEAVY DUTY WATER HOSE REELS

XL Size, Single and Dual Arm



SS304 SMALL & LARGE HOSE REEL VARIANTS



ZEPHYR HEAVY DUTY WATERING WAND



PRODUCT INDEX

AIR HOSE REELS

Auto-retractable Air Hose Reel - Medium	5
Auto-retractable Air Hose Reel - Heavy Duty	6
Auto-retractable Air Hose Reel - Dual Arm	7
Auto-retractable Air Hose Reel - Stainless Steel 304 (Food Grade)	8

WATER HOSE REELS

Auto-retractable Water Hose Reel - Medium	10
Auto-retractable Water Hose Reel - Heavy Duty	11
Auto-retractable Water Hose Reel - Dual Arm	12
Auto-retractable Water Hose Reel - Stainless Steel 304 (Food Grade)	13
Auto-retractable Water Hose Reel - Stainless Steel 304 (Food Grade) With Food Grade Hose	14

KITCHEN HOSE REELS

Auto-retractable Kitchen Wash-Stations - Heavy Duty	16
Auto-retractable Kitchen Wash-Stations - Dual Arm	17
Auto-retractable Kitchen Wash-Stations - Stainless Steel 304 (Food Grade)	18
Auto-retractable Kitchen Wash-Stations - Stainless Steel 304 (Food Grade) With Food Grade Hose	19
Auto-retractable Steam Hose Reel - Heavy Duty	20
Auto-retractable Steam Hose Reel - Dual Arm	21
Auto-retractable Steam Hose Reel - Stainless Steel 304 (Food Grade)	22

PRESSURE WASHER HOSE REELS

Auto-retractable Pressure Washer Hose Reel - Heavy Duty	23
Auto-retractable Pressure Washer Hose Reel - Dual Arm	24

FUEL & OIL HOSE REELS

Auto-retractable Oil Hose Reel - Heavy Duty	25
Auto-retractable Oil Hose Reel - Dual Arm	26
Auto-retractable Fuel / Oil Hose Reel - Heavy Duty XL (With Wire-braided Fuel Hose)	27
Auto-retractable Fuel / Oil Hose Reel - Dual Arm XL (With Wire-braided Fuel Hose)	28

PRE-RINSE FAUCETS

Pre-Rinse Faucet - Deck Mounted & Deck Mounted (U-Inlet)	29
Pre-Rinse Faucet - Wall Mounted, Wall Mounted (Base Model) & Deck Mounted (Base Model)	30

KITCHEN FAUCETS

Kitchen Faucet - 8" Wall Mounted	31
Kitchen Faucet - 8" Deck Mounted	32
Kitchen Faucet - 8" Deck Mounted	
Kitchen Faucet - Wall Mounted Retractable Pot Filler	

HOSES - AIR / WATER / OIL / SPRAY / STEAM

Next-gen Rubber Air Hoses - General Purpose Rubber Air Hose & Workshop Rubber Air Hose	34
Hot-n-Cold Rubber Water Hose	35
Pressure Washer Hoses & Oil Dispensing Hoses	36
Agriculture Spray Hoses & Steam Washdown Hoses	37
Sprayers - 9-mode, 8-mode, 8-mode HD, Heavy-Duty Pre-Rinse Sprayer	38

TOOLS & ACCESSORIES

Watering Wand, Sprinkler, Quick Connects, Converter Couplings, Shut-off Valve, Swivel Mount	39, 40
---	--------

HOSE REEL CART

Flat-Free Hose Reel Cart, Flat-Free Hose Reel Cart (with Turning Steering)	41
--	----

AIR HOSE REELS

Zephyr®



Keep it neat
Keep it easy



Auto-retractable Air Hose Reel



Hose Reel Features

- Superior Spring-Steel based auto-retraction mechanism
- 20-Gauge Steel Construction
- 12-Point ratchet for precise resolution
- Powder-coated Steel to resist corrosion
- Adjustable Outlet Arm
- 4-way Roller Guides
- Ceiling, Floor, Wall mounting options
- In-stock spare part programme



Powder Coated Steel Construction



12-point Ratchet

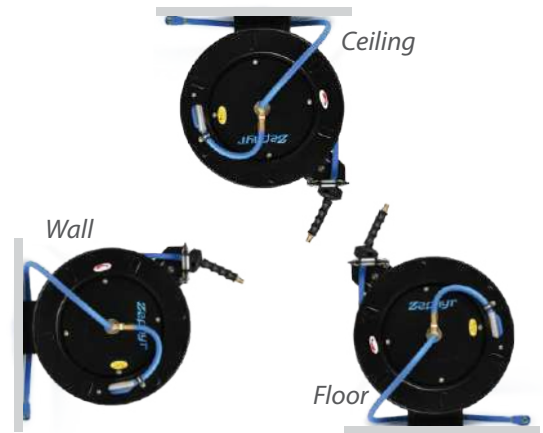

Multiple Mounting Options Ceiling, Wall & Floor

Hose Features

- 100% Rubber, 40% Lighter; almost as light as TPE hoses
- Twice as strong as regular rubber hoses
- Unmatched all-weather flexibility -45° to 82°C
- Polyester Braided Reinforcement
- Ozone and UV Resistant
- Working Pressure 20BAR; Burst Pressure 80BAR
- Also available with Oil-Shield Workshop Hose

*Append "-OS" at the end of SKUs for Oil Shield variants
All units include a 6ft Lead-in Hose and mounting hardware.
Swivel Mount is optional.*

Specifications

SKU	HOSE I.D (mm)	HOSE Length (mtrs.)
ZAR0610	6	10
ZAR0615	6	15
ZAR0810	8	10
ZAR0815	8	15
ZAR1010	10	10
ZAR1015	10	15
ZAR1308	13	7.5
ZAR1310	13	10
ZAR1315	13	15

Auto-retractable Air Hose Reel



Hose Reel Features

- Industrial-grade Spring-Steel based auto-retraction mechanism
- 18-Gauge Steel Construction
- 12-Point ratchet for precise resolution
- Powder-coated Steel to resist corrosion
- Adjustable Outlet Arm
- 4-way Roller Guides
- Ceiling, Floor, Wall mounting options
- In-stock spare part programme
- 1-Year Warranty

**XL Size Model
Now Available**



**Powder Coated
Steel Construction**



12-point Ratchet

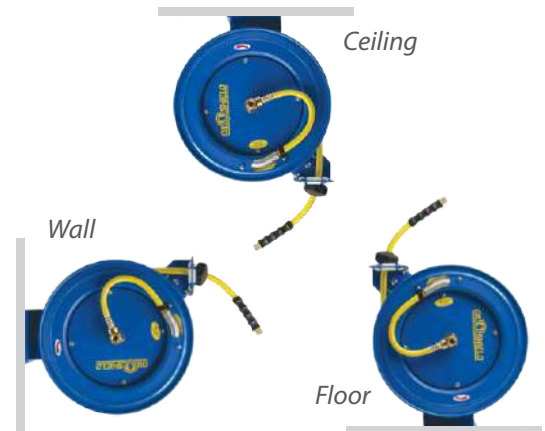

**Multiple Mounting Options
Ceiling, Wall & Floor**

Hose Features

- 100% Rubber, 40% Lighter; almost as light as TPE hoses
- Twice as strong as regular rubber hoses
- Unmatched all-weather flexibility -45° to 82°C
- Polyester Braided Reinforcement
- Ozone and UV Resistant
- Working Pressure 20BAR; Burst Pressure 80BAR
- Also available with Oil-Shield Workshop Hose

*Append "-OS" at the end of SKUs for Oil Shield variants
All units include a 6ft Lead-in Hose and mounting hardware.
Swivel Mount is optional.*

Specifications

SKU	HOSE I.D (mm)	HOSE Length (mtrs.)
ZAR0615HD	6	15
ZAR0620HD	6	20
ZAR0815HD	8	15
ZAR0820HD	8	20
ZAR1015HD	10	15
ZAR1020HD	10	20
ZAR1030HD	10	30
ZAR1315HD	13	15
ZAR1320HD	13	20
ZAR1330HD	13	30

Auto-retractable Air Hose Reel



Hose Reel Features

- Industrial-grade Spring-Steel based auto-retraction mechanism
- Dual-Arm frame for rough-n-tough use
- 18-Gauge Steel Construction
- 12-Point ratchet for precise resolution
- Powder-coated Steel to resist corrosion
- Adjustable Outlet Arm
- 4-way Roller Guides
- Ceiling, Floor, Wall mounting options
- In-stock spare part programme
- 2-Year Warranty

**XL Size Model
Now Available**



**Powder Coated
Steel Construction**



12-point Ratchet

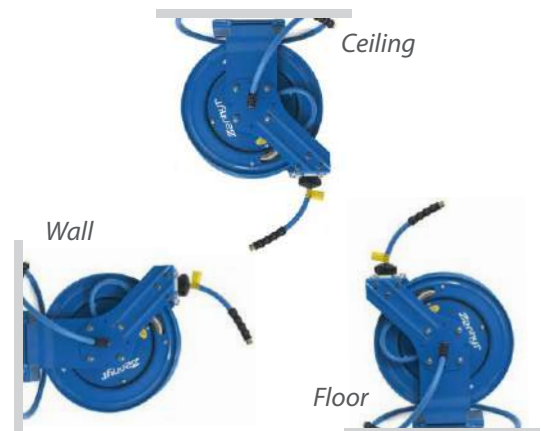

**Multiple Mounting Options
Ceiling, Wall & Floor**

Hose Features

- 100% Rubber, 40% Lighter; almost as light as TPE hoses
- Twice as strong as regular rubber hoses
- Unmatched all-weather flexibility -45° to 82°C
- Polyester Braided Reinforcement
- Ozone and UV Resistant
- Working Pressure 20BAR; Burst Pressure 80BAR
- Also available with Oil-Shield Workshop Hose

*Append "-OS" at the end of SKUs for Oil Shield variants
All units include a 6ft Lead-in Hose and mounting hardware.
Swivel Mount is optional.*

Specifications

SKU	HOSE I.D (mm)	HOSE Length (mtrs.)
ZAR0615DA	6	15
ZAR0815DA	8	15
ZAR1015DA	10	15
ZAR1020DA	10	20
ZAR1030DA	10	30
ZAR1315DA	13	15
ZAR1320DA	13	20
ZAR1330DA	13	30

Auto-retractable Air Hose Reel



Hose Reel Features

- Industrial-grade Spring-Steel based auto-retraction mechanism
- 18-Gauge Stainless Steel Rust-Resistant Construction
- Stainless Steel Fasteners
- 12-Point ratchet for precise resolution
- Adjustable Outlet Arm
- 4-way Roller Guides
- Ceiling, Floor, Wall mounting options
- In-stock spare part programme
- 1-Year Warranty

**Small & Large
Size Models
Now Available**



**Stainless
Steel Construction**



12-point Ratchet

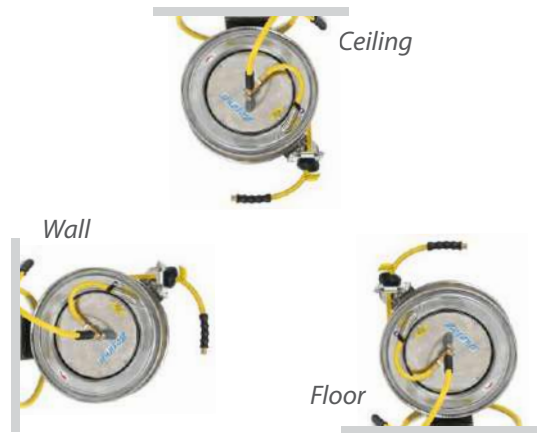

**Multiple Mounting Options
Ceiling, Wall & Floor**

Hose Features

- 100% Rubber, 40% Lighter; almost as light as TPE hoses
- Twice as strong as regular rubber hoses
- Unmatched all-weather flexibility -45° to 82°C
- Polyester Braided Reinforcement
- Ozone and UV Resistant
- Working Pressure 20BAR; Burst Pressure 80BAR
- Also available with Oil-Shield Workshop Hose

*Append "-OS" at the end of SKUs for Oil Shield variants
All units include a 6ft Lead-in Hose and mounting hardware.
Swivel Mount is optional.*

Specifications

SKU	HOSE I.D (mm)	HOSE Length (mtrs.)
ZAR0610SS	6	10
ZAR0615SS	6	15
ZAR0810SS	8	10
ZAR0815SS	8	15
ZAR1010SS	10	10
ZAR1015SS	10	15
ZAR1020SS	10	20
ZAR1308SS	13	7.5
ZAR1310SS	13	10
ZAR1315SS	13	15
ZAR1320SS	13	20

WATER HOSE REELS

Zephyr[®]



Keep it neat. Keep it easy.



Auto-retractable Water Hose Reel



Hose Reel Features

- Superior Spring-Steel based auto-retraction mechanism
- 20-Gauge Steel Construction
- 12-Point ratchet for precise resolution
- Powder-coated Steel to resist corrosion
- Adjustable Outlet Arm
- 4-way Roller Guides
- Ceiling, Floor, Wall mounting options
- In-stock spare part programme



Powder Coated Steel Construction



12-point Ratchet



**Multiple Mounting Options
Ceiling, Wall & Floor**

Hose Features

- 100% Rubber, 40% Lighter; almost as light as TPE hoses
- Twice as strong as regular rubber hoses
- Unmatched all-weather flexibility -45° to 82°C
- Polyester Braided Reinforcement
- Ozone and UV Resistant
- Handles Hot Water up to 95°C
- Working Pressure 10BAR; Burst Pressure 30BAR

Specifications

SKU	HOSE I.D (mm)	HOSE Length (mtrs.)
ZWR1308	13	7.5
ZWR1310	13	10
ZWR1315	13	15

Included Spray Gun - Standard 9-Mode Back-trigger

*All units include a 6ft Lead-in Hose and mounting hardware.
Swivel Mount and Quick-Connects are optional.*

Auto-retractable Water Hose Reel



Hose Reel Features

- Industrial-grade Spring-Steel based auto-retraction mechanism
- 18-Gauge Steel Construction
- 12-Point ratchet for precise resolution
- Powder-coated Steel to resist corrosion
- Adjustable Outlet Arm
- 4-way Roller Guides
- Ceiling, Floor, Wall mounting options
- In-stock spare part programme
- 1-Year Warranty

**XL Size Model
Now Available**



**Powder Coated
Steel Construction**



12-point Ratchet



**Multiple Mounting Options
Ceiling, Wall & Floor**

Hose Features

- 100% Rubber, 40% Lighter; almost as light as TPE hoses
- Twice as strong as regular rubber hoses
- Unmatched all-weather flexibility -45° to 82°C
- Polyester Braided Reinforcement
- Ozone and UV Resistant
- Handles Hot Water up to 95°C
- Working Pressure 10BAR; Burst Pressure 30BAR

Included Spray Gun - Heavy-Duty 8-Mode Front Trigger

*Reel available in **Black & Blue** colours, subject to availability*

*All units include a 6ft Lead-in Hose and mounting hardware.
Swivel Mount and Quick-Connects are optional.*

Specifications

SKU	HOSE I.D (mm)	HOSE Length (mtrs.)
ZWR1310HD	13	10
ZWR1315HD	13	15
ZWR1320HD	13	20
ZWR1325HD	13	25
ZWR1330HD	13	30
ZWR1915HD	19	15
ZWR1920HD	19	20
ZWR2515HD	25	15

Auto-retractable Water Hose Reel



Hose Reel Features

- Industrial-grade Spring-Steel based auto-retraction mechanism
- Dual-Arm frame for rough-n-tough use
- 18-Gauge Steel Construction
- 12-Point ratchet for precise resolution
- Powder-coated Steel to resist corrosion
- Adjustable Outlet Arm
- 4-way Roller Guides
- Ceiling, Floor, Wall mounting options
- In-stock spare part programme
- 2-Year Warranty

**XL Size Model
Now Available**



**Powder Coated
Steel Construction**



12-point Ratchet



**Multiple Mounting Options
Ceiling, Wall & Floor**

Hose Features

- 100% Rubber, 40% Lighter; almost as light as TPE hoses
- Twice as strong as regular rubber hoses
- Unmatched all-weather flexibility -45° to 82°C
- Polyester Braided Reinforcement
- Ozone and UV Resistant
- Handles Hot Water up to 95°C
- Working Pressure 10BAR; Burst Pressure 30BAR

Included Spray Gun - Heavy-Duty 8-Mode Front Trigger

*All units include a 6ft Lead-in Hose and mounting hardware.
Swivel Mount and Quick-Connects are optional.*

Specifications

SKU	HOSE I.D (mm)	HOSE Length (mtrs.)
ZWR1310DA	13	10
ZWR1315DA	13	15
ZWR1325DA	13	25
ZWR1330DA	13	30
ZWR1920DA	19	20
ZWR2515DA	25	15

Auto-retractable Water Hose Reel



Hose Reel Features

- Industrial-grade Spring-Steel based auto-retraction mechanism
- 18-Gauge Stainless Steel Rust-Resistant Construction
- Stainless Steel Fasteners
- 12-Point ratchet for precise resolution
- Adjustable Outlet Arm
- 4-way Roller Guides
- Ceiling, Floor, Wall mounting options
- In-stock spare part programme
- 1-Year Warranty

**Small & Large
Size Models
Now Available**



**Stainless
Steel Construction**



12-point Ratchet



**Multiple Mounting Options
Ceiling, Wall & Floor**

Hose Features

- 100% Rubber, 40% Lighter; almost as light as TPE hoses
- Twice as strong as regular rubber hoses
- Unmatched all-weather flexibility -45° to 82°C
- Polyester Braided Reinforcement
- Ozone and UV Resistant
- Handles Hot Water up to 95°C
- Working Pressure 10BAR; Burst Pressure 30BAR

Included Spray Gun - Heavy-Duty 8-Mode Front Trigger

*All units include a 6ft Lead-in Hose and mounting hardware.
Swivel Mount and Quick-Connects are optional.*

Specifications

SKU	HOSE I.D (mm)	HOSE Length (mtrs.)
ZWR1010SS	10	10
ZWR1020SS	10	20
ZWR1308SS	13	7.5
ZWR1310SS	13	10
ZWR1315SS	13	15
ZWR1320SS	13	20

Auto-retractable Water Hose Reel

With Food-grade Hose



Hose Reel Features

- Industrial-grade Spring-Steel based auto-retraction mechanism
- 18-Gauge Stainless Steel Rust-Resistant Construction
- Stainless Steel Fasteners
- 12-Point ratchet for precise resolution
- Adjustable Outlet Arm
- 4-way Roller Guides
- Ceiling, Floor, Wall mounting options
- In-stock spare part programme
- 1-Year Warranty

**Small & Large
Size Models
Now Available**



**Stainless
Steel Construction**



12-point Ratchet



**Multiple Mounting Options
Ceiling, Wall & Floor**

Hose Features (Thor Caser 10 C0B)

- White Smooth EPDM Rubber, Food Quality, Resistant to Heat, Complying With FDA Standards
- High Tensile Textile Plies
- Blue, Smooth Rubber, Resistant to Abrasion, Heat, Traces of Oil and Weather Condition, Fabric Impression
- -30°C Approx with peaks upto +160°C Approx.
- Mandrel Built Food Delivery Hose Also Suitable for Hot Water For Cleaning Service In the Food Industry For CIP

Included Spray Gun - Heavy-Duty 8-Mode Front Trigger

All units include a 6ft Lead-in Hose and mounting hardware. Swivel Mount and Quick-Connects are optional.

Specifications

SKU	HOSE I.D (mm)	HOSE Length (mtrs.)
ZWR1305SS-FH	13	05
ZWR1310SS-FH	13	10
ZWR1315SS-FH	13	15
ZWR1320SS-FH	13	20
ZWR1910SS-FH	19	10

KITCHEN HOSE REELS

Zephyr[®]



Keep it neat
Keep it easy



Auto-retractable Kitchen Wash-Stations



Hose Reel Features

- Industrial-grade Spring-Steel based auto-retraction mechanism
- 18-Gauge Steel Construction
- 12-Point ratchet for precise resolution
- Powder-coated Steel to resist corrosion
- Adjustable Outlet Arm
- 4-way Roller Guides
- Ceiling, Floor, Wall mounting options
- In-stock spare part programme
- 1-Year Warranty

**XL Size Model
Now Available**



**Powder Coated
Steel Construction**



12-point Ratchet



**Multiple Mounting Options
Ceiling, Wall & Floor**

Hose Features

- 100% Rubber, 40% Lighter; almost as light as TPE hoses
- Twice as strong as regular rubber hoses
- Unmatched all-weather flexibility -45° to 82°C
- Polyester Braided Reinforcement
- Ozone and UV Resistant
- Handles Hot Water up to 95°C
- Working Pressure 10BAR; Burst Pressure 30BAR

Specifications

SKU	HOSE I.D (mm)	HOSE Length (mtrs.)
ZWR1010HD-PR	10	10
ZWR1015HD-PR	10	15
ZWR1020HD-PR	10	20
ZWR1310HD-PR	13	10
ZWR1315HD-PR	13	15
ZWR1320HD-PR	13	20
ZWR1330HD-PR	13	30
ZWR1915HD-PR	19	15

All units include a 6ft Lead-in Hose and mounting hardware.
Swivel Mount and Quick-Connects are optional.

Included Sprayer - Heavy-Duty Pre-Rinse SS+Brass+POM

Auto-retractable Kitchen Wash-Stations



Hose Reel Features

- Industrial-grade Spring-Steel based auto-retraction mechanism
- Dual-Arm frame for rough-n-tough use
- 18-Gauge Steel Construction
- 12-Point ratchet for precise resolution
- Powder-coated Steel to resist corrosion
- Adjustable Outlet Arm
- 4-way Roller Guides
- Ceiling, Floor, Wall mounting options
- In-stock spare part programme
- 2-Year Warranty

**XL Size Model
Now Available**



**Powder Coated
Steel Construction**



12-point Ratchet



**Multiple Mounting Options
Ceiling, Wall & Floor**

Hose Features

- 100% Rubber, 40% Lighter; almost as light as TPE hoses
- Twice as strong as regular rubber hoses
- Unmatched all-weather flexibility -45° to 82°C
- Polyester Braided Reinforcement
- Ozone and UV Resistant
- Handles Hot Water up to 95°C
- Working Pressure 10BAR; Burst Pressure 30BAR

Specifications

SKU	HOSE I.D (mm)	HOSE Length (mtrs.)
ZWR1010DA-PR	10	10
ZWR1015DA-PR	10	15
ZWR1310DA-PR	13	10
ZWR1315DA-PR	13	15
ZWR1320DA-PR	13	20
ZWR1330DA-PR	13	30

All units include a 6ft Lead-in Hose and mounting hardware.
Swivel Mount and Quick-Connects are optional.

Included Sprayer - Heavy-Duty Pre-Rinse SS+Brass+POM

Auto-retractable Kitchen Wash-Stations



Hose Reel Features

- Industrial-grade Spring-Steel based auto-retraction mechanism
- Dual-Arm frame for rough-n-tough use
- 18-Gauge Steel Construction
- 12-Point ratchet for precise resolution
- Powder-coated Steel to resist corrosion
- Adjustable Outlet Arm
- 4-way Roller Guides
- Ceiling, Floor, Wall mounting options
- In-stock spare part programme
- 1-Year Warranty

**Small & Large
Size Models
Now Available**



**Stainless
Steel Construction**



12-point Ratchet

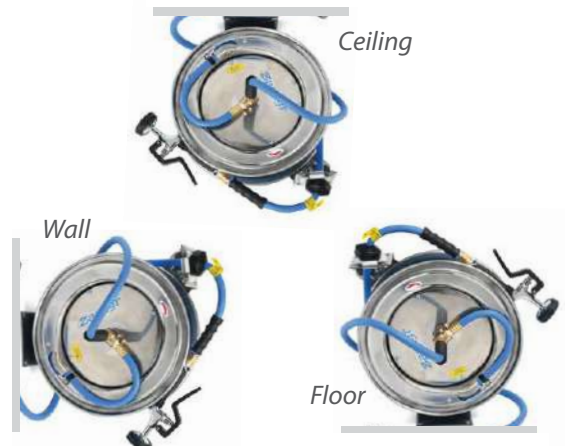

**Multiple Mounting Options
Ceiling, Wall & Floor**

Hose Features

- 100% Rubber, 40% Lighter; almost as light as TPE hoses
- Twice as strong as regular rubber hoses
- Unmatched all-weather flexibility -45° to 82°C
- Polyester Braided Reinforcement
- Ozone and UV Resistant
- Handles Hot Water up to 95°C
- Working Pressure 10BAR; Burst Pressure 30BAR

Specifications

SKU	HOSE I.D (mm)	HOSE Length (mtrs.)
ZWR1010SS-PR	10	10
ZWR1015SS-PR	10	15
ZWR1020SS-PR	10	20
ZWR1308SS-PR	13	7.5
ZWR1310SS-PR	13	10
ZWR1315SS-PR	13	15
ZWR1320SS-PR	13	20

All units include a 6ft Lead-in Hose and mounting hardware.
Swivel Mount and Quick-Connects are optional.

Included Sprayer - Heavy-Duty Pre-Rinse SS+Brass+POM

Auto-retractable Kitchen Wash-Stations

With Food-grade Hose



Hose Reel Features

- Industrial-grade Spring-Steel based auto-retraction mechanism
- Dual-Arm frame for rough-n-tough use
- 18-Gauge Steel Construction
- 12-Point ratchet for precise resolution
- Powder-coated Steel to resist corrosion
- Adjustable Outlet Arm
- 4-way Roller Guides
- Ceiling, Floor, Wall mounting options
- In-stock spare part programme
- 1-Year Warranty

**Small & Large
Size Models
Now Available**



**Stainless
Steel Construction**



12-point Ratchet

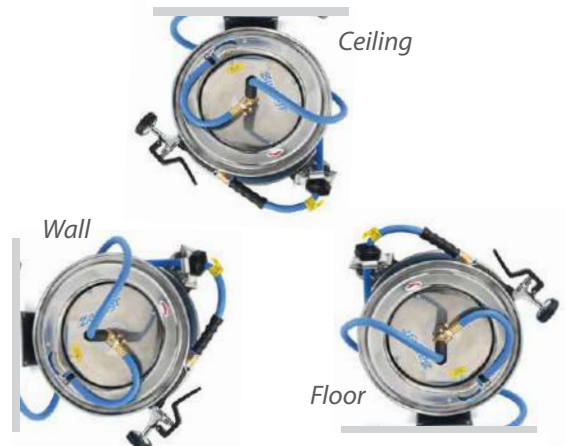

**Multiple Mounting Options
Ceiling, Wall & Floor**

Hose Features (Thor Caser 10 C0B)

- White Smooth EPDM Rubber, Food Quality, Resistant to Heat, Complying With FDA Standards
- High Tensile Textile Plies
- Blue, Smooth Rubber, Resistant to Abrasion, Heat, Traces of Oil and Weather Condition, Fabric Impression
- -30°C Approx with peaks upto +160°C Approx.
- Mandrel Built Food Delivery Hose Also Suitable for Hot Water For Cleaning Service In the Food Industry For CIP

Specifications

SKU	HOSE I.D (mm)	HOSE Length (mtrs.)
ZWR1305SS-PR-FH	13	05
ZWR1310SS-PR-FH	13	10
ZWR1315SS-PR-FH	13	15
ZWR1320SS-PR-FH	13	20
ZWR1910SS-PR-FH	19	10

All units include a 6ft Lead-in Hose and mounting hardware. Swivel Mount and Quick-Connects are optional.

Included Sprayer - Heavy-Duty Pre-Rinse SS+Brass+POM

Auto-retractable Steam Hose Reel



Hose Reel Features

- Industrial-grade Spring-Steel based auto-retraction mechanism
- 18-Gauge Steel Construction
- 12-Point ratchet for precise resolution
- Powder-coated Steel to resist corrosion
- Adjustable Outlet Arm
- 4-way Roller Guides
- Ceiling, Floor, Wall mounting options
- In-stock spare part programme
- 1-Year Warranty

**XL Size Model
Now Available**



**Powder Coated
Steel Construction**



12-point Ratchet

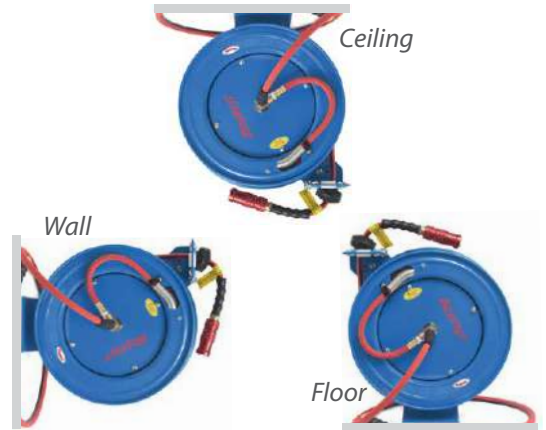

**Multiple Mounting Options
Ceiling, Wall & Floor**

Hose Features

- Rubber Steam Hose exceeds IS10655 Type 1
- Double Polyester Braid
- Rated for Saturated Steam at 160°C
- Ozone and UV Resistant
- Working Pressure 5.5 BAR; Burst Pressure 55 BAR
- Also available with food-grade hot water & steam hose

Specifications

SKU	HOSE I.D (mm)	HOSE Length (mtrs.)
ZSR1310HD	13	10
ZSR1315HD	13	15
ZSR1320HD	13	20
ZSR1325HD	13	25

All units include a 6ft Lead-in Hose and mounting hardware.
Swivel Mount is optional.

Included Sprayer - All-Metal Spray Nozzle

Auto-retractable Steam Hose Reel



Hose Reel Features

- Industrial-grade Spring-Steel based auto-retraction mechanism
- Dual-Arm frame for rough-n-tough use
- 18-Gauge Steel Construction
- 12-Point ratchet for precise resolution
- Powder-coated Steel to resist corrosion
- Adjustable Outlet Arm
- 4-way Roller Guides
- Ceiling, Floor, Wall mounting options
- In-stock spare part programme
- 2-Year Warranty

**XL Size Model
Now Available**



**Powder Coated
Steel Construction**



12-point Ratchet



**Multiple Mounting Options
Ceiling, Wall & Floor**

Hose Features

- Rubber Steam Hose exceeds IS10655 Type 1
- Double Polyester Braid
- Rated for Saturated Steam at 160°C
- Ozone and UV Resistant
- Working Pressure 5.5 BAR; Burst Pressure 55 BAR
- Also available with food-grade hot water & steam hose

Specifications

SKU	HOSE I.D (mm)	HOSE Length (mtrs.)
ZSR1310DA	13	10
ZSR1315DA	13	15
ZSR1320DA	13	20

All units include a 6ft Lead-in Hose and mounting hardware.
Swivel Mount is optional.

Included Sprayer - All-Metal Spray Nozzle

Auto-retractable Steam Hose Reel



Hose Reel Features

- Industrial-grade Spring-Steel based auto-retraction mechanism
- 18-Gauge Stainless Steel Rust-Resistant Construction
- Stainless Steel Fasteners
- 12-Point ratchet for precise resolution
- Adjustable Outlet Arm
- 4-way Roller Guides
- Ceiling, Floor, Wall mounting options
- In-stock spare part programme
- 1-Year Warranty

**Small & Large
Size Models
Now Available**



**Stainless
Steel Construction**



12-point Ratchet



**Multiple Mounting Options
Ceiling, Wall & Floor**

Hose Features

- Rubber Steam Hose exceeds IS10655 Type 1
- Double Polyester Braid
- Rated for Saturated Steam at 160°C
- Pin-pricked perforated cover
- Working Pressure 5.5 BAR; Burst Pressure 55 BAR
- Also available with food-grade hot water & steam hose

Specifications

SKU	HOSE I.D (mm)	HOSE Length (mtrs.)
ZSR1308SS	13	7.5
ZSR1310SS	13	10
ZSR1315SS	13	15
ZSR1320SS	13	20

All units include a 6ft Lead-in Hose and mounting hardware.
SS Swivel Mount is optional.

Included Sprayer - All-Metal Spray Nozzle

Auto-retractable Pressure Washer Hose Reel



Hose Reel Features

- Industrial-grade Spring-Steel based auto-retraction mechanism
- 18-Gauge Steel Construction
- 12-Point ratchet for precise resolution
- Powder-coated Steel to resist corrosion
- Adjustable Outlet Arm
- 4-way Roller Guides
- Ceiling, Floor, Wall mounting options
- In-stock spare part programme

**XL Size Model
Now Available**



**Powder Coated
Steel Construction**



12-point Ratchet

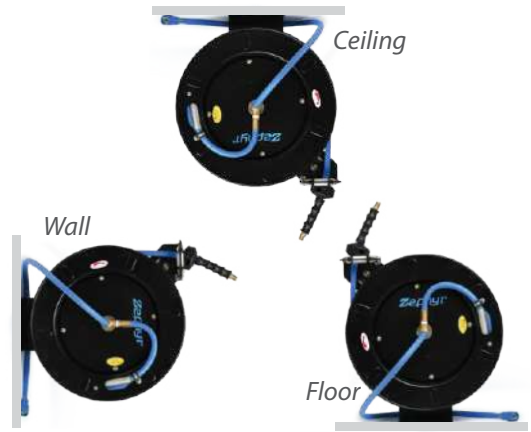

**Multiple Mounting Options
Ceiling, Wall & Floor**

Hose Features

- 100% Rubber, 35% Lighter (10mm)
- Aramid / Kevlar braided for superb flexibility and light weight (10mm)
- Polyester braided for 6mm size
- Handles hot water up to 120°C
- RMA Class A Oil-Resistant Tube
- 6mm ID: Working Pressure: 200BAR Burst Pressure: 800BAR
- 10mm ID: Working Pressure: 300BAR Burst Pressure: 1200BAR

Specifications

SKU	HOSE I.D (mm)	HOSE Length (mtrs.)
ZPW0615HD	6	15
ZPW0620HD	6	20
ZPW1015HD	10	15
ZPW1020HD	10	20
ZPW1025HD	10	25
ZPW1030HD	10	30

All units include a 6ft Lead-in Hose and mounting hardware.
Swivel Mount is optional.

Auto-retractable Pressure Washer Hose Reel



Hose Reel Features

- Industrial-grade Spring-Steel based auto-retraction mechanism
- Dual-Arm frame for rough-n-tough use
- 18-Gauge Steel Construction
- 12-Point ratchet for precise resolution
- Powder-coated Steel to resist corrosion
- Adjustable Outlet Arm
- 4-way Roller Guides
- Ceiling, Floor, Wall mounting options
- In-stock spare part programme
- 1-Year Warranty

**XL Size Model
Now Available**



**Powder Coated
Steel Construction**



12-point Ratchet

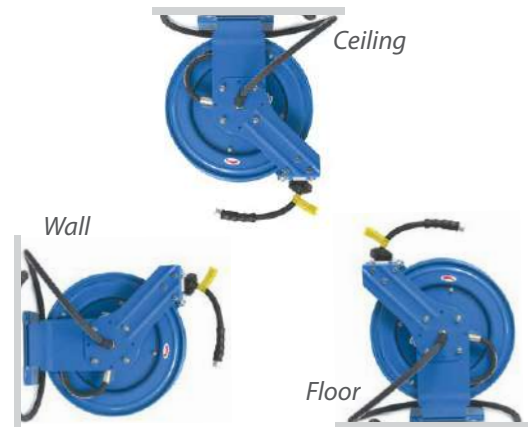

**Multiple Mounting Options
Ceiling, Wall & Floor**

Hose Features

- 100% Rubber, 35% Lighter (10mm)
- Aramid / Kevlar braided for superb flexibility and light weight (10mm)
- Polyester braided for 6mm size
- Handles hot water up to 120°C
- RMA Class A Oil-Resistant Tube
- 6mm ID: Working Pressure: 200BAR Burst Pressure: 800BAR
- 10mm ID: Working Pressure: 300BAR Burst Pressure: 1200BAR

Specifications

SKU	HOSE I.D (mm)	HOSE Length (mtrs.)
ZPW0615DA	6	15
ZPW0620DA	6	20
ZPW1015DA	10	15
ZPW1020DA	10	20
ZPW1030DA	10	30

All units include a 6ft Lead-in Hose and mounting hardware.
Swivel Mount is optional.

Auto-retractable Oil Hose Reel



Hose Reel Features

- Industrial-grade Spring-Steel based auto-retraction mechanism
- 18-Gauge Steel Construction
- 12-Point ratchet for precise resolution
- Powder-coated Steel to resist corrosion
- Adjustable Outlet Arm
- 4-way Roller Guides
- Ceiling, Floor, Wall mounting options
- In-stock spare part programme
- 1-Year Warranty

**XL Size Model
Now Available**



**Powder Coated
Steel Construction**



12-point Ratchet

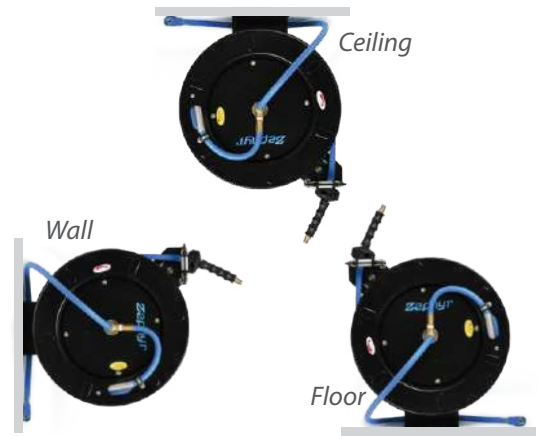

**Multiple Mounting Options
Ceiling, Wall & Floor**

Hose Features

- For fuel, oil and biodiesel dispensing from tanks
- Revolutionary formulation allows it to be thick yet light weight
- RMA Class A Oil-Resistant Tube and Cover
- 2x Kink Resistance takes care of major pain point
- 8" Internal Relief spring prevents kinking at the coupling end
- Anti-Static Wire allows use with electric pumps
- Working Pressure: 10BAR; Burst Pressure: 30BAR

*Gates or Parker Wire-Braid Hose Option Available.
Please see XL reel pages.*

*All units include a 6ft Lead-in Hose and mounting hardware.
Swivel Mount is optional.*

Specifications

SKU	HOSE I.D (mm)	HOSE Length (mtrs.)
ZOR1915HD	19	15
ZOR2510HD	25	10
ZOR2515HD	25	15

*Reel available in **Black & Blue** colours, subject to availability*

Auto-retractable Oil Hose Reel



Hose Reel Features

- Industrial-grade Spring-Steel based auto-retraction mechanism
- Dual-Arm frame for rough-n-tough use
- 18-Gauge Steel Construction
- 12-Point ratchet for precise resolution
- Powder-coated Steel to resist corrosion
- Adjustable Outlet Arm
- 4-way Roller Guides
- Ceiling, Floor, Wall mounting options
- In-stock spare part programme
- 1-Year Warranty

**XL Size Model
Now Available**



**Powder Coated
Steel Construction**

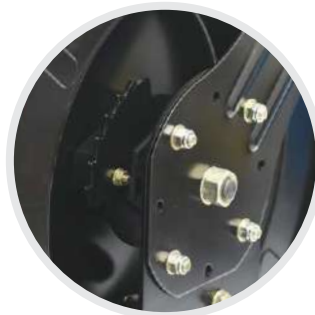

12-point Ratchet



**Multiple Mounting Options
Ceiling, Wall & Floor**

Hose Features

- For fuel, oil and biodiesel dispensing from tanks
- Revolutionary formulation allows it to be thick yet light weight
- RMA Class A Oil-Resistant Tube and Cover
- 2x Kink Resistance takes care of major pain point
- 8" Internal Relief spring prevents kinking at the coupling end
- Anti-Static Wire allows use with electric pumps
- Working Pressure: 10BAR; Burst Pressure: 30BAR

*Gates or Parker Wire-Braid Hose Option Available.
Please see XL reel pages.*

*All units include a 6ft Lead-in Hose and mounting hardware.
Swivel Mount is optional.*

Specifications

SKU	HOSE I.D (mm)	HOSE Length (mtrs.)
ZOR1915DA	19	15
ZOR1920DA	19	20
ZOR2510DA	25	10
ZOR2515DA	25	15

*Reel available in **Black & Blue** colours, subject to availability*

Auto-retractable Fuel / Oil Hose Reel

With Wire-braided Fuel Hose



Hose Reel Features

- Industrial-grade Spring-Steel based auto-retraction mechanism
- 18-Gauge Steel Construction
- 12-Point ratchet for precise resolution
- Powder-coated Steel to resist corrosion
- Heavy-duty steel retraction spring
- Adjustable Outlet Arm
- 4-way Roller Guides
- Ceiling, Floor, Wall mounting options
- In-stock spare part programme
- 1-Year Warranty



Powder Coated Steel Construction



12-point Ratchet



Multiple Mounting Options Ceiling, Wall & Floor

Hose Features

- Gates BlackSnake Fuel Hose
- Equivalent Parker Hose available
- Braided, high-tensile steel wire reinforcement
- Excellent collapse & kink resistance
- Smooth Finish cover
- Four-finger end-grips
- Max. Working Pressure: 10BAR / 150 PSI

Specifications

SKU	HOSE I.D (mm)	HOSE Length (mtrs.)
ZOR1915HD-X	19	15
ZOR2510HD-X	25	10

Reel available in **Black & Blue** colours, subject to availability

All units include a 6ft Lead-in Hose and mounting hardware.
Swivel Mount is optional.

Auto-retractable Fuel / Oil Hose Reel

With Wire-braided Fuel Hose



Hose Reel Features

- Industrial-grade Spring-Steel based auto-retraction mechanism
- Dual-Arm frame for rough-n-tough use
- 18-Gauge Steel Construction
- 12-Point ratchet for precise resolution
- Powder-coated Steel to resist corrosion
- Heavy-duty steel retraction spring
- Adjustable Outlet Arm
- 4-way Roller Guides
- Ceiling, Floor, Wall mounting options
- In-stock spare part programme
- 1-Year Warranty



Powder Coated Steel Construction



12-point Ratchet

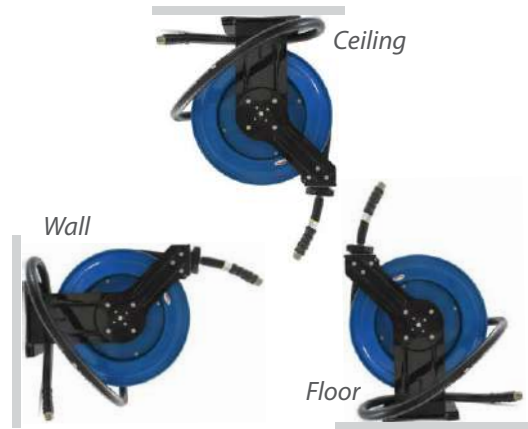

Multiple Mounting Options Ceiling, Wall & Floor

Hose Features

- Gates BlackSnake Fuel Hose
- Equivalent Parker Hose available
- Braided, high-tensile steel wire reinforcement
- Excellent collapse & kink resistance
- Smooth Finish cover
- Four-finger end-grips
- Max. Working Pressure: 10BAR / 150 PSI

Specifications

SKU	HOSE I.D (mm)	HOSE Length (mtrs.)
ZOR1915DA-X	19	15
ZOR2510DA-X	25	10

Reel available in **Black & Blue** colours, subject to availability

All units include a 6ft Lead-in Hose and mounting hardware.
Swivel Mount is optional.

Pre-Rinse Faucet - Deck Mounted



Zephyr®

- Hot & Cold water mixer
- Deck mounted, Single hole
- Brass compression cartridge w/ spring check valve
- Heavy duty BRASS construction, Zinc alloy Dual lever handles
- 47 1/8"(1120mm) overall height
- 20"(508mm) S/S riser , 12"(305mm) S/S wall bracket
- 37"(940mm) S/S flexible hose
- Food grade UPGRADE Spray Valve with laser logo "Zephyr", male thread 7/8"-20NPT
- Brass add-on body, S/S Swing Spout reach 12"(305mm)
- Comes with 2pcs 600mm water inlet hose

Finish Polished Chrome, Black

SKU ZPRFD1

Pre-Rinse Faucet - Deck Mounted (U-Inlet)



Zephyr®

- Hot & Cold water mixer
- Deck mounted, Single hole
- U-Inlet: 4"(102mm) centers , 1/4" -18NPT male thread
- Brass compression cartridge w/ spring check valve
- Heavy duty BRASS construction, Zinc alloy Dual lever handles
- 47 1/8"(1120mm) overall height
- 20"(508mm) S/S riser , 12"(305mm) S/S wall bracket
- 37"(940mm) S/S flexible hose
- Food grade UPGRADE Spray Valve with laser logo "Zephyr", male thread 7/8"-20NPT
- Brass add-on body, S/S Swing Spout 12"(305mm)

Finish Polished Chrome, Black

SKU ZPRFD2

Pre-Rinse Faucet - Wall Mounted



Zephyr®

- Hot & Cold water mixer
- Wall mounted, dual holes, 1/2NPT thread,
- 2pcs eccentric flange w/ adjustable center 196mm-212mm
- Brass compression cartridge w/ spring check valve
- Heavy duty BRASS construction, Zinc alloy Dual lever handles
- 47 1/8"(1120mm) overall height
- 20"(508mm) S/S riser , 12"(305mm) S/S wall bracket
- 37"(940mm) S/S flexible hose
- Food grade UPGRADE Spray Valve with laser logo"Zephyr", male thread 7/8"-20NPT
- Brass add-on body, S/S Swing Spout 12"(305mm)

Finish Polished Chrome, Black

SKU ZPRFW2

Pre-Rinse Faucet - Wall Mounted (Without Faucet)

Zephyr®



- Hot & Cold water mixer
- Wall mounted, dual holes, 1/2NPT thread
- Adjustable center 196mm-212mm
- Brass compression cartridge w/ spring check valve
- Heavy duty BRASS construction, Zinc alloy Dual lever handles
- 47 (1193mm) overall height
- 20"(508mm) S/S riser , 12"(305mm) S/S wall bracket
- 37"(940mm) S/S flexible hose
- Food grade UPGRADE Spray Valve with laser logo"Zephyr", male thread 7/8"-20NPT

Finish Polished Chrome, Black

SKU ZPRFW3

Pre-Rinse Faucet - Deck Mounted (Base Model)

Zephyr®



- Hot & Cold water mixer
- Deck mounted, Single hole
- Ceramic cartridge
- Heavy duty BRASS construction, Zinc alloy 3-wing handles
- 47 1/8"(1120mm) overall height
- 20"(508mm) S/S riser , 12"(305mm) S/S wall bracket
- 37"(940mm) S/S flexible hose
- Food grade UPGRADE Spray Valve with laser logo"Zephyr", male thread 7/8"-20NPT
- Brass add-on body, S/S Swing Spout 12"(305mm)
- Comes with 2pcs. 600mm water inlet hose

Finish Polished Chrome, Black

SKU ZPRFD3



Kitchen Faucet - 8" Wall Mounted



Zephyr®

- Hot & Cold water mixer
- Wall mounted
- 8" Center, 2pcs. eccentric flange w/ adjustable center 196mm- 212mm
- Heavy duty BRASS construction, Zinc alloy Dual lever handles
- 8 7/16"(215mm) overall height
- S/S Swing Spout 12"(305mm)

Finish Polished Chrome

SKU ZPRFW-F1

Kitchen Faucet - 8" Deck Mounted



Zephyr®

- Hot & Cold water mixer
- Deck mounted
- 8" Center, 2pcs. eccentric flange w/ adjustable center 196mm- 212mm
- Brass compression cartridge w/ spring check valve
- Heavy duty BRASS construction, Zinc alloy Dual lever handles
- 9 9/16"(243mm) overall height
- **S/S Swing Spout 8 7/16" (214mm)**

Finish Polished Chrome

SKU ZPRFD-F1

Kitchen Faucet - 8" Deck Mounted



Zephyr®

- Hot & Cold water mixer
- Deck mounted
- 8" Center, 2pcs. eccentric flange w/ adjustable center 196mm- 212mm
- Heavy duty BRASS construction, Zinc alloy Dual lever handles
- 9 9/16"(243mm) overall height
- **S/S Swing Spout 12"(305mm)**

Finish Polished Chrome

SKU ZPRFD-F2

Kitchen Faucet - Wall Mounted Retractable Pot Filler

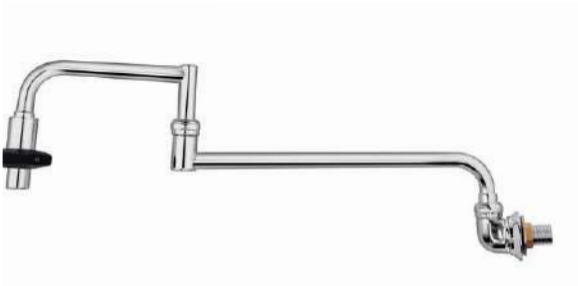

Zephyr®

- Wall Mount Pot Filler Faucet, Cold water supply
- Double Joint Nozzle, Back (310mm), Front (155mm)
- Body Material: Brass
- Nozzle Material: Stainless steel
- Inlet thread size: G1/2"
- Lever type: Control grip on the tip of the Nozzle

Finish Polished Chrome

SKU ZPRFW-F2

NEXT GEN RUBBER HOSES

Zephyr®



The lightest and strongest multipurpose rubber hoses

The revolutionary formulation of Zephyr hoses lets them have the flexibility and versatility of the best of rubber hoses and yet be 40% lighter than regular rubber hoses.

This makes them the most easy-to-use rubber hoses you can find on the market, and yet these won't get stiff and crack and burst like those plastic hoses. No need to bother about replacing hoses every now and then.

Unmatched All-weather Flexibility

Tired of replacing plastic / hybrid hoses that crack and get stiff every winter? And become noodle-like soft in summers? Forget about all of that with Zephyr which have unmatched cold weather performance and remains flexible even until -45°C. And remains as strong and solid up til 82°C. So if you work, it works.

Professional Performance

The Zephyr hoses are designed for professionals and heavy-duty use. Over 25 years of listening to the end-users, RMX came up with BluBird and Zephyr. And now, these are the finest hoses a professional can have.

With a safety factor of 4:1, they can sustain high pressures for a long time. Zephyr hoses can carry hot water up to 95°C with ease and for long durations. So, whether or not you use it, it has much more potential than any other hose on the market.

Backed up with a 10-year warranty

All these claims are backed up by a 10-year replacement warranty against manufacturing defects. Enough said.



With Zephyr Rubber Hoses for Air & Water, you get superb performance and safety. And ultimately, peace of mind so you can work better.

Next-gen Rubber Air Hoses



Zephyr®

General Purpose Rubber Air Hose

- 100% Rubber, 40% Lighter; almost as light as TPE hoses
- Twice as strong as regular rubber hoses
- Unmatched all-weather flexibility -45° to 82°C
- Polyester Braided Reinforcement
- Ozone and UV Resistant
- Working Pressure 20BAR; Burst Pressure 80BAR
- A variety of optional Crimped Brass End-Fittings
- 10-Year Warranty



40%
LIGHTER



2x
STRONGER



OIL SHIELD

Workshop Rubber Air Hose

- Award-Winning Evolution of a Revolution
- 100% Rubber, 35% Lighter
- Twice as strong as regular rubber hoses
- RMA Class A Oil Resistant Tube and Cover
- Class-leading fire and welding splatter resistance
- Resists Diesel, Oil, Grease on shop floors
- Working Pressure 20BAR; Burst Pressure 80BAR
- A variety of optional Crimped Brass End-Fittings
- **WINNER, TOP 20 TOOLS - MOTOR MAGAZINE USA**
- 3-Year Warranty



**RMA Class A
Oil Resistant**



**Welding Splatter
Resistant**

Zephyr - Specifications

SKU	HOSE I.D (mm)	HOSE O.D (mm)
ZA06	6	12.5
ZA08	8	14.5
ZA10	10	16
ZA13	13	20
ZA19	19	28.5
ZA25	25	36

Oil Shield - Specifications

SKU	HOSE I.D (mm)	HOSE O.D (mm)
OS06	6	12.5
OS08	8	14.5
OS10	10	16
OS13	13	20
OS19	19	28.5
OS25	25	36

Next-gen Rubber Water Hoses



Zephyr®

Hot-n-Cold Rubber Water Hose

- 100% Rubber, 40% Lighter; almost as light as TPE hoses
- Twice as strong as regular rubber hoses
- Unmatched all-weather flexibility -45° to 82°C
- Handles Hot-water up to 95°C
- Polyester Braided Reinforcement
- Ozone and UV Resistant
- Working Pressure 10BAR; Burst Pressure 30BAR
- Standard packaged hoses with fittings available
- 10-Year Warranty
- Compatible with Zephyr Sprayers and Quick-Connects



40%
LIGHTER



2x
STRONGER

Specifications

SKU	HOSE I.D (mm)	HOSE O.D (mm)	HOSE Length (mtrs.)
ZW10	10	16	1
ZW13	13	20	1
ZW16	16	22	1
ZW19	19	26	1
ZW25	25	33	1
ZW1308	13	20	7.5
ZW1315	13	20	15
ZW1330	13	20	30
ZW1908	19	26	7.5
ZW1915	19	26	15
ZW1930	19	26	30
ZW2515	25	33	15
ZW2530	25	33	30



All Weather Flexibility



Hot Water up to 95°C



4:1 Safety Factor



10 Year Warranty

Next-gen Pressure Washer Hoses



Pressure Washer Hoses - With an Armour!

- 100% Rubber, 35% Lighter (10mm)
- Aramid / Kevlar braided for superb flexibility and light weight (10mm)
- Polyester braided for 6mm size
- Handles hot water up to 120°C
- RMA Class A Oil-Resistant Tube
- 6mm ID: Working Pressure: 200BAR Burst Pressure: 800BAR
- 10mm ID: Working Pressure: 300BAR Burst Pressure: 1200BAR
- 1-Year Warranty

Specifications

SKU	HOSE I.D (mm)	HOSE O.D (mm)	WP (BAR)
ZPW06	6	13.5	200
ZPW10	10	17	300

Next-gen Oil Dispensing Hoses



What makes it special?

- For fuel, oil and biodiesel dispensing from tanks
- Revolutionary formulation allows it to be thick yet light weight
- RMA Class A Oil-Resistant Tube and Cover
- 2x Kink Resistance takes care of major pain point
- 8" Internal Relief spring prevents kinking at the coupling end
- Anti-Static Wire allows use with electric pumps
- Working Pressure: 10BAR; Burst Pressure: 30BAR

Specifications

SKU	HOSE I.D (mm)	HOSE O.D (mm)
OD19	19	26
OD25	25	36

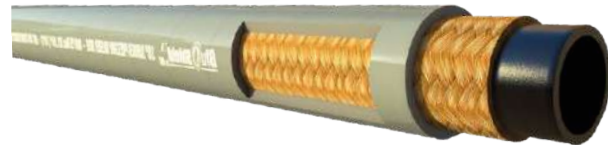

Next-gen Agriculture Spray Hoses



Zephyr®

What makes it special?

- 100% Rubber, 40% Lighter; almost as light as TPE hoses
- Twice as strong as regular rubber hoses
- Chemical resistant tube and cover
- Compatible with pesticides, insecticides, herbicides like Lasso
- Unmatched all-weather flexibility -45° to 82°C
- Handles Hot-water up to 120°C
- Ozone and UV Resistant
- Working Pressure 20BAR; Burst Pressure 80BAR
- 2-Year Warranty

Specifications

SKU	HOSE I.D (mm)	HOSE O.D (mm)
AS10	10	16
AS13	13	20
AS19	19	25.4

Next-gen Steam Washdown Hoses



Zephyr®

What makes it special?

- Special EPDM Tube and Cover
- Rubber Steam Hose exceeds IS10655 Type 1
- Double Polyester Braid
- Rated for Saturated Steam at 160°C
- Pin-pricked perforated cover
- Working Pressure 5.5 BAR; Burst Pressure 55 BAR

Specifications

SKU	HOSE I.D (mm)	HOSE O.D (mm)
ZS13	13	23



9-mode Spray Gun (ZSP004)

- Class leading 9 modes of spraying water make it a no-brainer for efficient watering and washing, makes it all fun and saves water too
- High performance allows working up till 20BAR of pressure.
- Heavy duty, metal construction with chrome finish
- Rubberized ergonomic grip
- Locking clip can be switched when one wants to spray without having to press the trigger, allows for relaxed use.



8-mode Spray Gun (ZSP002)

- 8 modes of spraying water make it a no-brainer for efficient watering and washing, makes it all fun and saves water too
- High performance allows working up till 20BAR pressure.
- Ergo flow control allows you to adjust the outflow in a jiffy.
- Heavy duty construction
- Rubberized ergonomic grip



Heavy-Duty

8-mode Spray Gun (ZSP001HD)

- 8-Modes of Water Spraying
- Efficient Spraying that Saves Water
- Heavy-Duty Industrial Construction
- Locking clip to spray without pressing
- Water Flow-control Knob
- Front-trigger for better control
- Max. Pressure up to 20BAR



Heavy-Duty

Pre-Rinse Sprayer (ZPR001)

- No-Screw Design for Spray Face avoids latent leaking due to corroded screw
- Heavy-Duty SS, Brass and POM Blastic Plastic Construction
- Built-in Water Sealing EPDM Washer
- SS 304 Spring for long-life
- High-Pressure & Powerful Jet Spray
- Easy assembly, disassembly for maintenance
- Max. Pressure up to 60BAR

Finish Polished Chrome, Black

All Zephyr hoses ship with standard 3/4" BSP fittings which will fit this spray gun.



8-mode Watering Wand (ZWW001HD)

- 8-Pattern Wash for all your watering needs - Shower, Centre, Cone, Stream, Vertical, Flat, Mist, Full.
- Effortless sliding thumb-valve. All-in-one thumb control adjusts water flow without hand fatigue.
- 36" to 60" Extensible Lightweight, rust-proof aluminium shaft makes long use super easy.
- 180° Adjustable Head for superb customizability. Sponge holder for a comfortable grip. Added hook for easy storage.
- Plug to fit with any ½" hose. Remove the plug to work with any Zephyr hose with end-fittings.



Heavy-Duty



Sprinkler (ZSPRK001)



- Oscillating Sprinkler.
- Multi-position dial for a variety of watering patterns.
- Maintenance free, scaled water motor.
- Precision spray tube with threaded tube tip for cleaning..
- Approx. area coverage 3200 sq.ft.
- 18 nozzle jets provide uniform watering.

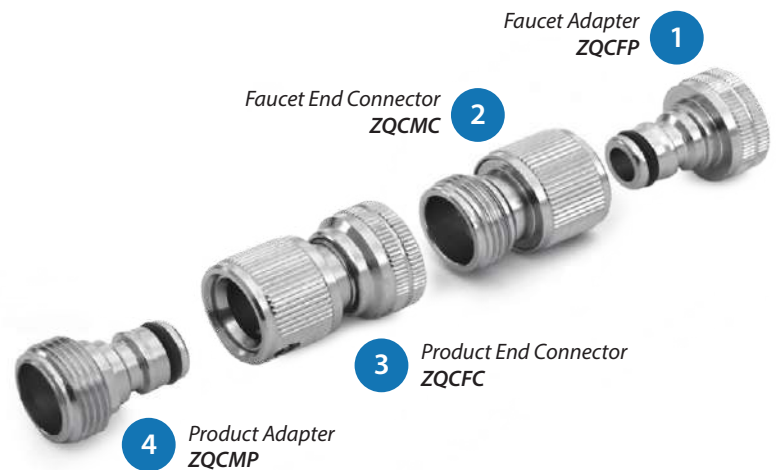

Zephyr Quick Connects

Complete 4-piece Kit	ZQC4P	Female Universal Coupler	ZQCFC
Faucet - Hose Combo	ZQCFHC	Male Universal Plug	ZQCMC
Sprayer - Hose Combo	ZQCSHC	Female Universal Plug	ZQCFP
Male Universal Coupler	ZQCMC		



Watch Demo Videos



Scan this code to watch video

<https://bit.ly/2wctKmP>

<https://bit.ly/2FKPUMs>



Converter Couplings



- Converter couplings to convert the threads of the fittings from male-to-female, female-to-male or to change the sizes between 1/2" and 3/4".
- All-brass construction makes it ideal for long and durable use with water systems.

Zephyr Converter Couplings

3/4" Female to 1/2" Female	ZCT34M12F
3/4" Female to 1/2" Male	ZCT34M12M
3/4" Female to 3/4" Male	ZCT34M34M

Shut-off Valve

- Shut-off valve / tap with solid all brass construction for rust-free and long use.
- Smooth low-resolution lever for quick & easy watering. Goes from zero to full flow.
- Zero-leak technology supporting high-pressure water.
- Compatible with all Zephyr supplied products (Quick-connects, hoses, hose reels) with 3/4" end- fittings as well as with standard sized watering equipment in market.



Smooth Low Resolution Lever

Swivel Mount (for Hose Reels)



A perfect companion to the Zephyr Hose Reel.

- Increases manoeuvrability & ease of use
- Heavy-duty Powder Coated Steel
- Provides 140° rotation
- Wall & Ceiling Mountable. Mounts Easily to Wood, Bricks or Concrete
- Also available in SS304, colour is subject to availability



ZSM001 - For Medium-duty reels
 ZSM001HD - For Heavy duty reels
 ZSM001DA - For Dual-arm reels
 ZSM001SS - For SS304 reels

Zephyr Flat-Free Hose Reel Cart



- 10" Flat-Free tyres for worry-free use
- Industrial Powder-coated steel construction
- Non-Slip handle
- Low-Center of Gravity prevents tripping
- Storage Basket
- Solid Axles for rough terrain
- Includes heavy-duty 8-mode spray gun*
- Includes 6ft lead-in hose
- Easy Assembly

Specifications

SKU	Hose Size and Length
ZRC	Empty
ZRC13120	13mm x 120m (400ft)
ZRC16120	16mm 120m (400ft)
ZRC19090	19mm x 90m (300ft)
ZRC25060	25mm x 60m (200ft)



10" Flat Free Tyres



Heavy-duty 8-mode spray gun

Zephyr Flat-Free Hose Reel Cart with Turning Steering



- Turning Steering / Handle for easier manoeuvrability
- 10" Flat-Free tyres for worry-free use
- Industrial Powder-coated steel construction
- Non-Slip handle
- Low-Center of Gravity prevents tripping
- Storage Basket
- Solid Axles for rough terrain
- Includes heavy-duty 8-mode spray gun*
- Includes 6ft lead-in hose
- Easy Assembly

Specifications

SKU	Hose Size and Length
ZRC	Empty
ZRC13120T	13mm x 120m (400ft)
ZRC16120T	16mm 120m (400ft)
ZRC19090T	19mm x 90m (300ft)
ZRC25060T	25mm x 60m (200ft)

*Spray Gun only included with models optioned with hose

** Color and finish is subject to availability



A series of 18 thin, light grey horizontal lines spaced evenly down the page, providing a template for handwritten notes.



Zephyr®

www.zephyr.live | sales@zephyr.live | +91 844-844-4565

RMX Rubber Pvt. Ltd.
GSTIN: 03AADCR5608K1ZF

Factory	Sales Office
72-73 Industrial Estate Extension, Jalandhar, 144012 Punjab, India	C-612, Nirvana Courtyard Nirvana Country, Sector 50 Gurgaon - 122018, Haryana, India



YouTube Videos



Download PDF